

# USB-1608HS Series

## 16-Bit Simultaneous Sampling DAQ Devices

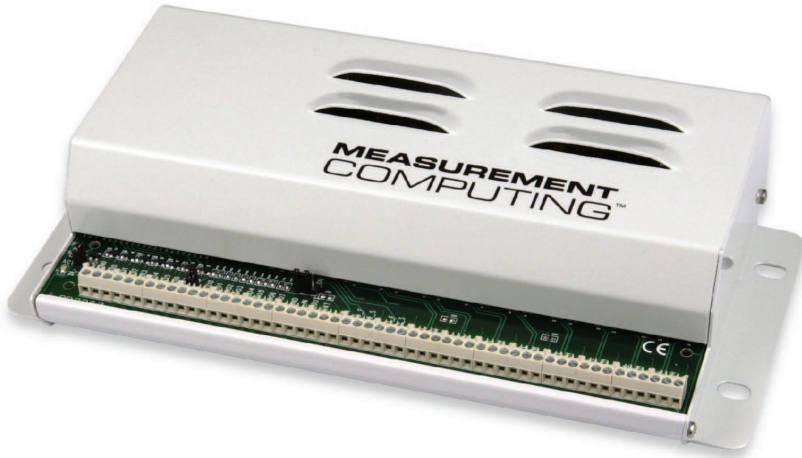

The USB-1608HS Series provides simultaneous sampling at rates up to 250 kS/s per channel.

### Features

- Simultaneous analog sampling
- Sample rates up to 250 kS/s per channel
- Eight SE or DIFF analog inputs
- Up to two analog outputs
- 8 digital inputs and 8 digital outputs
- One trigger input
- One event counter
- External 5 V power adapter and DIN rail clips included

### Supported Operating Systems

- Windows® 10/8/7/Vista®/XP 32/64-bit

### Overview

With one A/D converter per channel, the USB-1608HS Series offers true simultaneous sampling of up to eight 16-bit analog inputs at 250 kHz per channel.

The USB-1608HS Series is housed in a heavy-duty chassis with integrated mounting slots, ensuring that the hardware is rugged enough for any DAQ application. A required external power supply is included.

### Analog Input

The USB-1608HS Series provides eight single-ended or eight differential analog inputs. Users can mix SE and DIFF channels. Each input has a dedicated 16-bit A/D converter for true simultaneous sampling per channel. The input range is software-selectable, and the sample rate is 250 kS/s per channel. Users can pace operations with an internal or external clock.

### Analog Output

The USB-1608HS-2AO provides two independent, 16-bit analog voltage outputs. The throughput rate is 70 kS/s for one channel, and 35 kS/s for two channels. Users can clock output operations with the onboard scan clock.

Users can enable remote sensing for each output to compensate for any voltage drop error that may occur.

### Digital I/O

The 16 digital I/O lines are configured as 8 inputs and 8 outputs. The digital I/O transfer rate is up to 8000 port or single bit reads/writes per second, system-dependent.

Users can configure the pull-up/down configuration with onboard jumpers. Each DIO pin has an associated LED to indicate the digital input/output state.

### Trigger Input

An analog trigger input can be used to start an acquisition. The trigger threshold range is  $\pm 10$  V. The threshold resolution 12 bits. Users can set the following trigger options:

- Positive or negative slope
- Edge or level sensitive
- Retrigger on or off

The trigger is automatically rearmed after acquiring a specified number of samples.

### Counter Input

The counter channel is a TTL-level input to a 32-bit event counter. The counter increments when the TTL level transitions from low to high. The counter can count frequencies of up to 1 MHz.

### Clock I/O

Users can pace operations with the internal clock or with an external source. Two terminals are provided for external clocking and multi-unit synchronization:

- SYNC\_IN externally paces A/D conversions. TTL-level input signals of up to 250 kHz are supported.
- SYNC\_OUT outputs the clock for A/D conversions.

Users can connect the SYNC\_OUT pin on one device to the SYNC\_IN pin of a second device and acquire data synchronously from 16 analog input channels.

USB-1608HS Series Selection Chart

Model	Analog Input	Sample Rate per Channel (max)	Analog Output	Digital I/O	Counter Input	Clock Source
USB-1608HS	8 SE/ 8 DIFF	250 kS/s	0	8 input 8 output	1	Internal, external input and output
USB-1608HS-2AO	8 SE/ 8 DIFF	250 kS/s	2	8 input 8 output	1	Internal, external input and output

# USB-1608HS Series

## Overview

### Power

The USB-1608HS Series requires external power. A 5 V power adapter (PS-5V2AEPS) is included with each shipment.

### Calibration

The USB-1608HS Series is factory-calibrated using a NIST-traceable calibration process. Specifications are guaranteed for one year.

The USB-1608HS Series also supports field calibration for users to calibrate the device locally with the InstaCal utility.

USB-1608HS Series Block Diagram

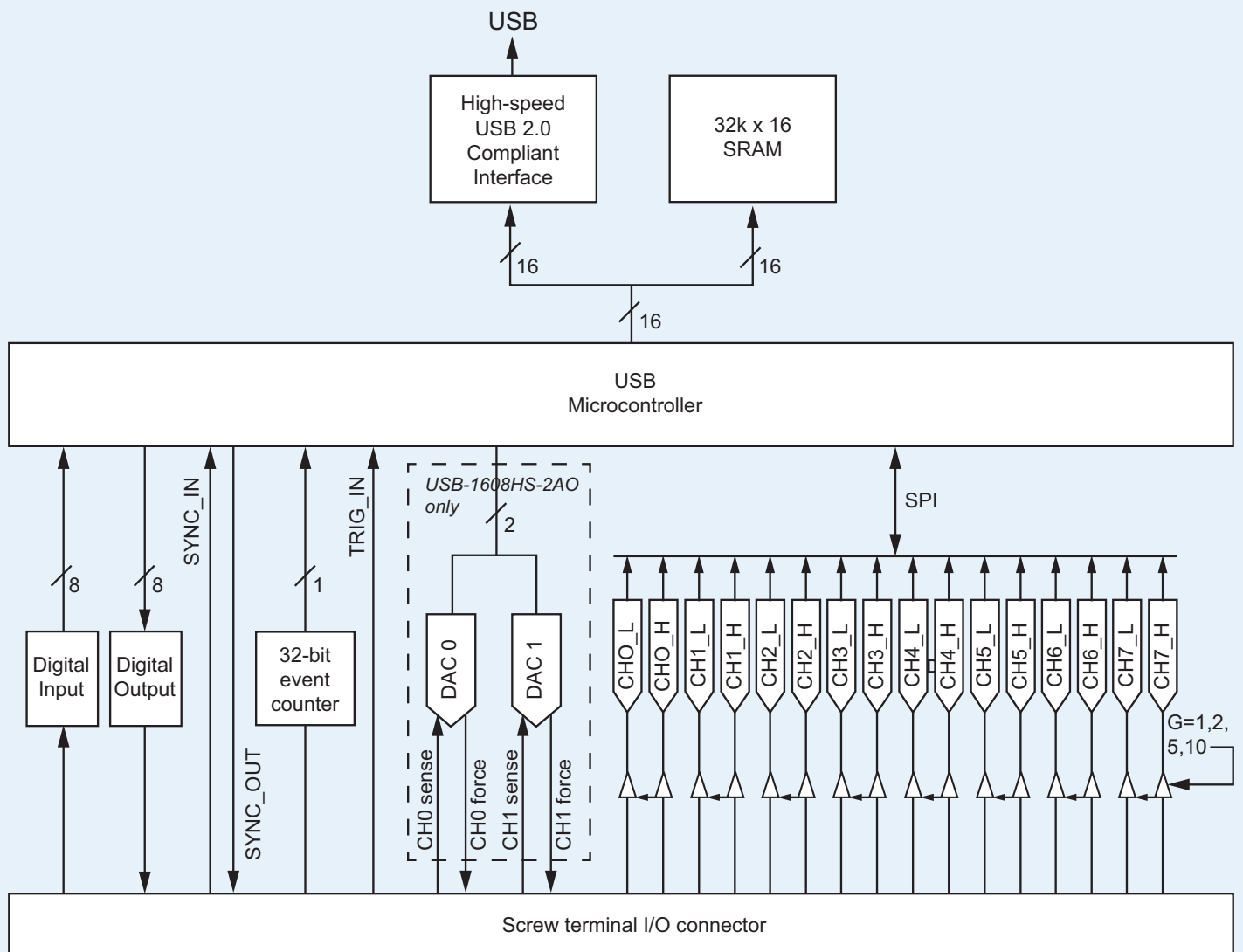







# USB-1608HS Series

## Software

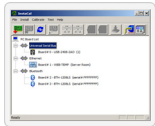

### Software Support

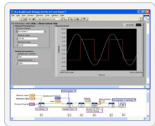
The USB-1608HS Series is supported by the software in the table below.

Ready-to-Run Applications	
<a href="#">DAQami™</a> 	Data acquisition companion software with drag-and-drop interface that is used to acquire, view, and log data, and generate signals. DAQami can be configured to log analog, digital, and counter channels, and to view that data in real-time or post-acquisition on user-configurable displays. Logged data can be exported for use in Excel® or MATLAB®. Windows OS DAQami is included with the free MCC DAQ Software bundle (CD/download). Install DAQami and try the fully-functional software for 30 days. After 30 days, all features except for data logging and data export will continue to be available – data logging and data export features can be unlocked by purchasing the software.
<a href="#">InstaCal™</a> 	An interactive installation, configuration, and test utility for MCC hardware. Windows OS InstaCal is included with the free MCC DAQ Software bundle (CD/download).
<a href="#">TracerDAQ™ and TracerDAQ Pro</a> 	Virtual strip chart, oscilloscope, function generator, and rate generator applications used to generate, acquire, analyze, display, and export data. Supported features may vary by hardware. The Pro version provides enhanced features. Windows OS TracerDAQ is included with the free MCC DAQ Software bundle (CD/download). TracerDAQ Pro is available as a purchased software download.
General-Purpose Programming Support	
<a href="#">Universal Library™ (UL)</a> 	Library for developing applications in C, C++, VB, C# .Net, VB .Net, and Python. Windows OS The UL is included with the free MCC DAQ Software bundle (CD/download).
<a href="#">Linux® driver</a> 	Open-source Linux drivers are available for most MCC devices. Example programs are also provided.
Application-Specific Programming Support	
<a href="#">ULx for NI LabVIEW™</a> 	A comprehensive library of VIs and example programs for NI LabVIEW that is used to develop custom applications that interact with most MCC devices. Windows OS ULx for NI LabVIEW is included with the free MCC DAQ Software bundle (CD/download).
<a href="#">DASYLab®</a> 	Icon-based data acquisition, graphics, control, and analysis software that allows users to create complex applications in minimal time without text-based programming. Windows OS DASYLab is available as a purchased software download. An evaluation version is available for 28 days.
<a href="#">MATLAB® driver</a> 	High-level language and interactive environment for numerical computation, visualization, and programming. The Mathworks Data Acquisition Toolbox™ allows users to acquire data from most MCC PCI and USB devices. Visit <a href="http://www.MathWorks.com">www.MathWorks.com</a> for more information about the Data Acquisition Toolbox.

# USB-1608HS Series

## Specifications



### Specifications

These specifications apply to both standard and OEM versions unless noted.

#### Analog Input

**A/D converter type:** 16-bit successive approximation type  
**Number of channels:** Eight differential or eight single-ended  
**Input configuration:** Individual A/D per channel  
**Sampling method:** Simultaneous  
**Analog input modes**

**Power up and reset state:** CHx\_H and CHx\_L inputs are disconnected from their screw terminal pins and internally connected to GND; recommended configuration for unused inputs.

**Single-ended:** CHx\_H inputs are connected directly to their screw terminal pins. CHx\_L inputs are disconnected from their screw terminal pins and internally connected to GND.

**Differential:** CHx\_H and CHx\_L inputs are connected directly to their screw terminal pins.

**Absolute maximum input voltage:**

CHx IN to GND:  $\pm 25$  V max (power on)

TRIG\_IN to GND:  $\pm 15$  V max (power off)

**Input impedance (CHx IN):** 1 G $\Omega$  (power on), 1.5 k $\Omega$  (power off)

**Input bandwidth (-3 dB)** (all input ranges): 330 kHz

**Input leakage current:**  $\pm 25$  pA

**Input capacitance:** 50 pF

**Input ranges** (software-selectable per channel):  $\pm 10$  V,  $\pm 5$  V,  $\pm 2$  V,  $\pm 1$  V

**A/D pacing:** Onboard A/D clock, external source (SYNC\_IN). Refer to [“External Clock Input/Output” on page 5](#).

**A/D trigger source:** TRIG\_IN input. Refer to [“External Trigger” on page 5](#).

**A/D trigger modes:** External analog. Refer to [“External Trigger” on page 5](#).

**Maximum working voltage** (signal + common mode): FSR  $\pm 0.05\%$  FSR max

**Sampling rate:** 0.009 S/s to 250 kS/s, software-selectable

**Throughput**

Software paced: 33 to 8000 S/s all channels, system dependent

Scan to PC memory: 250 kS/s per channel max (limited on USB 1.1 ports)

**Resolution:** 16 bits

**Differential non-linearity**

Calibrated:  $\pm 2.0$

Uncalibrated:  $\pm 0.5$  LSB typ,  $\pm 1.0$  LSB max (applies to the entire 0  $^{\circ}$ C to 55  $^{\circ}$ C temperature range)

**CMRR (60 Hz)**

$\pm 10$  V: 81 dB min

$\pm 5$  V: 81 dB min

$\pm 2$  V: 92 dB min

$\pm 1$  V: 92 dB min

Calibrated Absolute Accuracy	
Range (V)	Accuracy (mV)
$\pm 10$	$\pm 7.019$
$\pm 5$	$\pm 3.509$
$\pm 2$	$\pm 1.403$
$\pm 1$	$\pm 0.702$

Accuracy Components					
Range (V)	Integral Non-Linearity (% FSR)	Gain Error at FS (mV)	Offset (mV)	Gain Tempco (ppm/ $^{\circ}$ C)	Offset Tempco ( $\mu$ V/ $^{\circ}$ C)
$\pm 10$	0.00915	4.578	1.526	3.8	19.5
$\pm 5$	0.00915	2.289	0.763	7.0	19.5
$\pm 2$	0.00915	0.916	0.305	16.5	24.3
$\pm 1$	0.00915	0.458	0.153	40.1	29.2

All values are  $\pm$ . When connecting differential inputs to floating input sources, the user must provide a DC return path from each differential input to ground by connecting a resistor from each differential input to AGND. A value of approximately 100 k $\Omega$  can be used for most applications.

Noise Performance		
Range (V)	Peak to Peak Noise (Counts)	RMS Noise (LSBrms)
$\pm 10$	8	1.21
$\pm 5$	8	1.21
$\pm 2$	8	1.21
$\pm 1$	8	1.21

All values are  $\pm$ . Noise distribution is determined by gathering 50 kS with inputs tied to ground at the user connector. Samples are gathered at the maximum specified sampling rate of 250 kS/s.

#### Analog Output (USB-1608HS-2AO only)

**Number of channels:** Two independent

**Resolution:** 16 bits

**Output range:**  $\pm 10$  V

**Throughput**

Single channel: 70 kS/s

Two channel: 35 kS/s

**Pacer source:** Onboard D/A clock

**Monotonicity:** 16 bits

**Glitch energy:** 200 nV/s

**Current output:**  $\pm 10$  mA max single channel,  $\pm 20$  mA max two channels.

The maximum load that the analog output can drive is calculated by dividing the full scale output voltage by the current output specification or (10 V/10 mA) = 1000  $\Omega$ . This calculation is valid whether the remote sense feature is enabled or disabled.

**Output short-circuit protection** (Output connect to GND): 100 ms max

**Output coupling:** DC

**Power up and reset state:** DACs clear to midscale, (0 V,  $\pm 20$  mV). Remote sense is disabled.

**Remote sense configuration:** Enabled or disabled through software control.

**Remote sense compliance voltage** (Note 4):  $\pm 10.75$  V max

The remote sense feature can compensate for any series resistance up to 75  $\Omega$  between its force terminal pins and its output load.

**Remote sense compensation range** (Note 5): 0 to 75  $\Omega$  max

$R_{load}$  should not exceed the specified 1000  $\Omega$ , and  $R_{series}$  should not exceed its specified limit of 75  $\Omega$ .

**Output noise:** 100 nV/Hz

**Settling time** (to 0.003%):

20 V output step, (RL = 5 k $\Omega$ , CL = 200 pF): 5  $\mu$ S max

**Slew rate:** 10 V/ $\mu$ s

**Absolute accuracy:**  $\pm 0.25\%$  of FSR max

**Offset error drift:**  $\pm 4$  ppm/ $^{\circ}$ C

**Gain error drift:**  $\pm 10$  ppm/ $^{\circ}$ C

#### Analog Input Calibration

**Recommended warm-up time:** 15 minutes min

**Calibration method:** Software calibration

**Calibration interval:** 1 year

**Calibration reference:**  $\pm 10.000$  V,  $\pm 5$  mV max. Actual measured values stored in EEPROM

**Tempco:** 5 ppm/ $^{\circ}$ C max

**Long term stability:** 30 ppm/1000 h

#### Digital Input/Output

**Digital type:** 5 V CMOS

**Number of I/O:** 16

**Configuration:** Eight input, eight output

**Pull-up/down configuration:** The eight input pins have 47 k $\Omega$  resistors that may be configured to either pull-up or pull-down with a jumper.

**Digital I/O transfer rate:** System dependent, 33 to 8000 port reads/writes or single bit reads/writes per second.

**Input high voltage:** 2.0 V min, 5.5 V absolute max

**Input low voltage:** 0.8 V max,  $-0.5$  V absolute min

**Output high voltage:** (IOH =  $-2.5$  mA): 3.8 V min

**Output low voltage:** (IOL = 2.5 mA): 0.7 V max

**Power on and reset state:** Outputs: driven low

**LED indicators:** Each I/O pin has an associated LED status indicator. A high state turns the LED on. The LEDs may be disabled with jumpers JP1 (input LEDs) and JP2 (output LEDs).

# USB-1608HS Series

## Ordering



### External Trigger

Trigger source: TRIG\_IN input

Trigger input range:  $\pm 10$  V max

Absolute maximum input voltage

TRIG\_IN to GND:  $\pm 25$  V max (power on),  $\pm 15$  V max (power off)

Trigger threshold levels:  $\pm 10$  V/4096; software-selectable.

Input impedance: 1 M $\Omega$  (power on), 1.5 k $\Omega$  (power off)

Trigger modes: Positive/negative slope, edge/level sensitive, retrigger on/off

Threshold resolution: 12 bits, 1 in 4096

Threshold accuracy:  $\pm 0.25\%$  FSR

Hysteresis:  $\pm 5$  mV

Full power bandwidth ( $-3$  dB): 640 kHz

### External Clock Input/Output

Pin names: SYNC\_IN, SYNC\_OUT

Pin type

SYNC\_IN: Input; receives the A/D pacer clock signal from an external source; rising edge sensitive.

SYNC\_OUT: Output; outputs the A/D pacer clock signal. Over-current protected with a 200  $\Omega$  series resistor.

Input clock rate: 250 kHz max

Clock pulse width

SYNC\_IN: 1  $\mu$ s min

SYNC\_OUT: 2  $\mu$ s min

Input leakage current:  $\pm 2.0$   $\mu$ A

Input high voltage: 3.5 V min, 6.5 V absolute max

Input low voltage: 1.5 V max,  $-0.5$  V absolute min

Output high voltage

IOH =  $-2.5$  mA: 3.3 V min

No load: 3.8 V min

Output low voltage

IOL = 2.5 mA: 1.1 V max

No load: 0.6 V max

### Counter

Pin name: CTR

Counter type: Event counter; Schmitt trigger input protected with a 1 k $\Omega$  series resistor.

Number of channels: 1

Input type: TTL, rising edge triggered

Input source: CTR screw terminal

Resolution: 32 bits

Schmitt trigger hysteresis: 0.58 V to 0.93 V

Input leakage current:  $\pm 5$   $\mu$ A

Maximum input frequency: 1 MHz

High pulse width: 500 ns min

Low pulse width: 500 ns min

Input high voltage: 2.4 V min, 6.5 V absolute max

Input low voltage: 2.19 V max,  $-0.5$  V absolute min

### Power

Supply current

Continuous mode: 920 mA. This is the total current requirement, and does not include any additional contribution due to the power output pin current, analog output source current, or DIO loading.

+5V EXT pin output voltage range: 4.5 V min, 5.25 V max. Output voltage range assumes that the input power supply is within specified limits.

+5V EXT pin output current: +10 mA max. This is the total amount of current that can be sourced for general use from the power output pin.

External power input: +5.0 VDC

External power adapter: +5 V,  $\pm 5\%$  @ 2 A (MCC p/n PS-5V2AEPS included)

### Environmental

Operating temperature range: 0  $^{\circ}$ C to 55  $^{\circ}$ C max

Storage temperature range:  $-40$   $^{\circ}$ C to 85  $^{\circ}$ C max

Humidity: 0% to 90% non-condensing

### Mechanical

Dimensions (L  $\times$  W  $\times$  H)

Board: 203.2  $\times$  121.9  $\times$  15.2 mm (8.0  $\times$  4.8  $\times$  0.6 in.)

Enclosure: 241.3  $\times$  125.7  $\times$  58.9 mm (9.50  $\times$  4.95  $\times$  2.32 in.)

## Order Information

### Hardware

Part No.	Description
USB-1608HS	16-bit, 250 kS/s device with eight SE and eight DIFF simultaneous sampling analog inputs, one counter, and 16 DIO lines. Includes USB cable, external power supply (PS-5V2AEPS), MCC DAQ software CD, and DIN rail mounting clips.
USB-1608HS-2AO	16-bit, 250 kS/s device with eight SE and eight DIFF simultaneous sampling analog inputs, two analog outputs, one counter, and 16 DIO lines. Includes USB cable, external power supply (PS-5V2AEPS), MCC DAQ software CD, and DIN rail mounting clips.
PS-5V2AEPS	Replacement power supply; interchangeable plugs are available separately.

## Software also Available from MCC

Part No.	Description
DAQami	Data acquisition companion software for acquiring data and generating signals
TracerDAQ Pro	Out-of-the-box virtual instrument suite with strip chart, oscilloscope, function generator, and rate generator – professional version
DASylab	Icon-based data acquisition, graphics, control, and analysis software