

USB-1208HS Series

13-Bit Multifunction High Speed DAQ Devices



All USB-1208HS Series devices provide eight singled-ended or four differential analog inputs at up to a 1 MS/s sampling rate, and 16 digital I/O.

Features

- Up to 8 analog inputs
- 13-bit resolution
- Sample rates up to 1 MS/s
- Up to 4 analog outputs
- 16 digital I/O lines
- Two 32-bit counters
- One timer output
- USB bus powered

Supported Operating Systems

- Windows® 10/8/7/Vista®XP, 32/64-bit
- Android™

Overview

USB-1208HS Series devices are low-cost, 13-bit devices that offer four differential (DIFF) or eight single-ended (SE) analog inputs, 16 digital I/O channels, two counter inputs, and one timer output. A digital trigger lets you start analog input or output conversions.

The USB-1208HS-2AO includes two analog outputs and the USB-1208HS-4AO includes four analog outputs.

Analog Input

Each device supports software-selectable ranges from ± 5 V to ± 20 V in differential mode, and software-selectable ranges from ± 2.5 V to ± 10 V, and 0 V to 10 V in single-ended mode.

Sample Rate

USB-1208HS Series devices can sample at a maximum of 1 MS/s in hardware paced mode.

External Clock I/O

Each device has an external clock input terminal that supports input signals up to 1 MHz to pace A/D conversions from an external source.

The USB-1208HS-2AO/USB-1208HS-4AO also have an external clock input terminal that supports input signals up to 1 MHz to pace D/A conversions from an external source.

Each device has a clock output terminal to output the A/D sampling clock. The USB-1208HS-2AO/USB-1208HS-4AO also have a clock output terminal to output the D/A sampling clock.

Analog Output

The USB-1208HS-2AO provides two 12-bit analog outputs, and the USB-1208HS-4AO provides four 12-bit analog outputs. The output range is ± 10 V. Each output can update at a maximum rate of 1 MS/s.

Digital I/O

Users can program each of the 16 TTL-level digital I/O lines for either input or output.

Each USB-1208HS Series device has a user-configurable internal jumper to configure the digital bits for pull-up or pull-down (default).

Counter Input

Each device supports two 32-bit TTL-level counters that accept frequency inputs of up to 20 MHz.

Timer Output

USB-1208HS Series devices include a pulse width modulation (PWM) timer output with a software-selectable frequency range up to 20 MHz.

Calibration

USB-1208HS Series devices are factory-calibrated using a NIST-traceable calibration process. Specifications are guaranteed for one year. For calibration beyond one year, return the device to the factory for recalibration.

USB-1208HS Series Selection Chart					
Model	Analog Inputs	Sampling Rate	Analog Outputs	Digital I/O	Counters
USB-1208HS	8 SE/4 DIFF	Up to 1 MS/s	0	16	2
USB-1208HS-2AO	8 SE/4 DIFF	Up to 1 MS/s	2	16	2
USB-1208HS-4AO	8 SE/4 DIFF	Up to 1 MS/s	4	16	2







USB-1208HS Series

Software

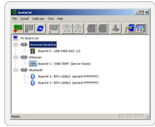

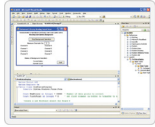
Software Support

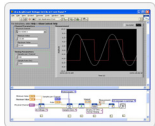
USB-1208HS Series devices are supported by the software in the table below.

Ready-to-Run Applications	
DAQami™	 <p>Data acquisition companion software with drag-and-drop interface that is used to acquire, view, and log data, and generate signals. DAQami can be configured to log analog, digital, and counter channels, and to view that data in real-time or post-acquisition on user-configurable displays. Logged data can be exported for use in Excel® or MATLAB®. Windows OS</p> <p>DAQami is included with the free MCC DAQ Software bundle (CD/download). Install DAQami and try the fully-functional software for 30 days. After 30 days, all features except for data logging and data export will continue to be available – data logging and data export features can be unlocked by purchasing the software.</p>
InstaCal™	 <p>An interactive installation, configuration, and test utility for MCC hardware. Windows OS</p> <p>InstaCal is included with the free MCC DAQ Software bundle (CD/download).</p>
TracerDAQ™ and TracerDAQ Pro	 <p>Virtual strip chart, oscilloscope, function generator, and rate generator applications used to generate, acquire, analyze, display, and export data. Supported features may vary by hardware. The Pro version provides enhanced features. Windows OS</p> <p>TracerDAQ is included with the free MCC DAQ Software bundle (CD/download). TracerDAQ Pro is available as a purchased software download.</p>
General-Purpose Programming Support	
Universal Library™ (UL)	 <p>Library for developing applications in C, C++, VB, C# .Net, VB .Net, and Python. Windows OS</p> <p>The UL is included with the free MCC DAQ Software bundle (CD/download).</p>
UL for Android™	 <p>Programming library of Java classes for programmers who develop apps for Android-based tablets and phones. UL for Android communicates with select MCC DAQ devices. Supports Android project development on Windows, Linux, Mac OS X</p> <p>UL for Android is included with the free MCC DAQ Software bundle (CD/download).</p>
Linux® driver	 <p>Open-source Linux drivers are available for most MCC devices. Example programs are also provided.</p>
Application-Specific Programming Support	
ULx for NI LabVIEW™	 <p>A comprehensive library of VIs and example programs for NI LabVIEW that is used to develop custom applications that interact with most MCC devices. Windows OS</p> <p>ULx for NI LabVIEW is included with the free MCC DAQ Software bundle (CD/download).</p>
DASYLab®	 <p>Icon-based data acquisition, graphics, control, and analysis software that allows users to create complex applications in minimal time without text-based programming. Windows OS</p> <p>DASYLab is available as a purchased software download. An evaluation version is available for 28 days.</p>
MATLAB® driver	 <p>High-level language and interactive environment for numerical computation, visualization, and programming. The Mathworks Data Acquisition Toolbox™ allows users to acquire data from most MCC PCI and USB devices.</p> <p>Visit www.MathWorks.com for more information about the Data Acquisition Toolbox.</p>

USB-1208HS Series

Specifications

USB-1208HS Series Block Diagram

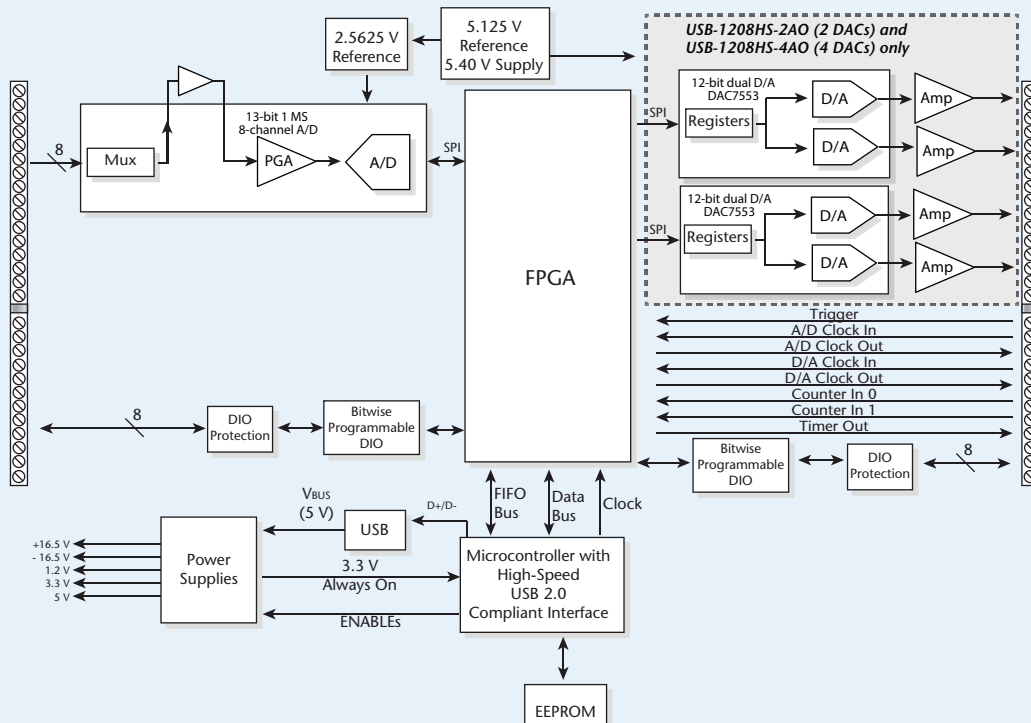

Specifications

General

Environment

Operating temperature range: 0 °C to 50 °C
Storage temperature range: -40 °C to 85 °C
Humidity: 0% to 90% non-condensing

Communications: USB 2.0 (high-speed)

Acquisition data buffer: 4 kS

Vibration: MIL STD 810E Category 1 and 10

Signal I/O connector: 2 banks of screw-terminal blocks

Dimensions (L × W × H): 127.00 × 88.90 × 35.56 mm (5.00 × 3.50 × 1.40 in.)

Weight: 431 g (0.95 lb)

Analog Input

A/D converter: Successive approximation type

Input ranges: Software-selectable per channel

DIFF: ±20 V, ±10 V, ±5 V (the voltage level on each individual AIN input is limited to ±14 V.)

SE: ±10 V, ±5 V, ±2.5 V, 0 – 10 V

Number of channels: 4 DIFF/8 SE (software-selectable)

Input configuration: Multiplexed

Channel gain queue: 8 unique consecutive elements, software-selectable range for each channel

Absolute maximum input voltage: CHx IN to GND

Power on: ±25 V max

Power off: ±12 V max

Input impedance: 35 MΩ min

Input bandwidth (-3 dB): All input ranges, 2 MHz typ

Input leakage current: ±250 nA typ

Input capacitance: 32 pF typ

Offset error drift: 5 ppm/°C typ

Gain error drift: 25 ppm/°C typ

Maximum working voltage (signal + common mode)

±20 V: ±14 V

±10 V: ±11 V

±5 V: ±5.5 V

Sample rate: 1 S/s to 1 MS/s, software-selectable

Sample clock source: Internal A/D clock or AICKI

Burst mode: Software-selectable, burst rate = 1 μs

Throughput

Software-paced: 33 S/s to 4000 S/s typ, system-dependent

Hardware-paced: 1 MS/s max

Resolution: 13 bits

A/D no missing codes (uncalibrated)

DIFF mode: 13 bits

SE mode: 12 bits

CMRR: 60 Hz, 74 dB typ

Crosstalk

SE mode (all ranges, 250 kHz input signal): -62 dB typ

DIFF mode (all ranges, 250 kHz input signal): -78 dB typ

Voltage Range	Calibrated Absolute Accuracy (LSB)	Noise Performance*	
		Typical Counts	LSB _{rms}
DIFF mode			
±20 V	±9.55 typ, ±13.18 max	3	0.45
±10 V	±4.59 typ, ±6.23 max	3	0.45
±5 V	±2.25 typ, ±2.75 max	3	0.45
SE mode			
±10 V	±5.10 typ, ±8.06 max	5	0.91
±5 V	±2.63 typ, ±4.03 max	5	0.91
±2.5 V	±1.59 typ, ±2.70 max	5	0.91
0 V to 10 V	±3.29 typ, ±5.13 max	5	0.91

* Noise distribution is determined by gathering 50 kS with inputs tied to ground at the user connector. Samples are gathered at the max rate of 1 MS/s.

USB-1208HS Series

Specifications



Input Settling Time in μs , Typical \pm Full-Scale Channel Switch, Same-Range to Same-Range			
Range	± 1 LSB	± 4 LSB	± 8 LSB
± 10 V	1.5	1.1	1.0
± 5 V	2.1	1.1	1.0
± 2.5 V	2.2	1.1	1.0
0 V to 10 V	2.6	1.1	1.0

Analog Output (USB-1208HS-2AO/USB-1208HS-4AO Only)

D/A converter: Texas Instruments DAC7553

Number of channels

USB-1208HS-2AO: 2 independent

USB-1208HS-4AO: 4 independent

Resolution: 12 bits

Output range

Calibrated: ± 10 V

Uncalibrated: ± 10.2 V

Output transient: Host PC is reset, powered on, suspended, or a reset command is issued to device.

Duration: 3 ms typ

Amplitude: 6 V p-p typ

D/A update rate

Software paced: 33 S/s to 5000 S/s typ, system-dependent

Hardware paced: 1 MHz max (per channel)

Sample clock source: Internal D/A clock or AOCKI (AO external clock input pin)

Monotonicity: 12 bits

Output current: ± 3 mA max per channel

Output short-circuit protection: Output connect to GND, unlimited duration (10 mA typ)

Output coupling: DC

Power up and reset state: 0 V

Output noise: 0.53 mV rms

Settling time (to 0.05%): 20 V output step, (RL=5 k Ω , CL=200 pf), 5 μs max.

Absolute accuracy: $\pm 0.1\%$

Slew rate: 6.7 V/ μs typ

Offset error drift: 10 ppm/ $^{\circ}\text{C}$ typ

Gain error drift: 65 ppm/ $^{\circ}\text{C}$ typ

Digital I/O

Digital type: CMOS

Number of I/O: 16

Configuration: Each bit may be configured as input (power on default) or output

Pull-up/down configuration: The port has 47 k Ω resistors; jumper configurable

Digital I/O transfer rate (system paced): 33 to 8000 port reads/writes or single-bit reads/writes per second typ, system-dependent

Input high voltage: 2.0 V min, 5.5 V absolute max

Input low voltage: 0.8 V max, -0.5 V absolute min, 0 V recommended min

Output high voltage: 4.4 V min (IOH = -50 μA), 3.76 V min (IOH = -24 mA)

Output low voltage: 0.1 V max (IOL = 50 μA), 0.44 V max (IOL = 24 mA)

Output current: ± 24 mA max per terminal

External Scan Trigger Input

Trigger source: TRIG input (can trigger an A/D scan, a D/A scan, or both)

Trigger mode: Software-selectable for edge- or level-sensitive, rising or falling edge, high or low level. Power on default is edge sensitive, rising edge.

Trigger latency: 1 μs + 1 clock cycle max

Trigger pulse width: 100 ns min

Input type: Schmitt Trigger, 33 Ω series resistor and 47 k Ω pull-down to ground

Schmitt trigger hysteresis: 0.4 V to 1.2 V

Input high voltage: 2.2 V min, 5.5 V absolute max

Input low voltage: 1.5 V max, -0.5 V absolute min, 0 V recommended min

External Scan Clock I/O

Terminal names

USB-1208HS: AICKI, AICKO

USB-1208HS-2AO/1208HS-4AO: AICKI, AICKO, AOCKI, AOCKO

Terminal types

AxCKI: Input, active on rising edge

AxCKO: Output, power on default is 0 V, active on rising edge

Terminal descriptions

AxCKI: Receives sampling clock from external source

AxCKO: Outputs internal sampling clock (D/A or A/D clock) or pulse generated from AxCKI when in external clock mode

Input clock rate: 1 MHz max

Clock pulse width

AxCKI: 400 ns min

AxCKO: 400 ns min

Input type: Schmitt trigger, 33 Ω series resistor, 47 k Ω pull-down to ground

Schmitt trigger hysteresis: 0.4 V to 1.2 V

Input high voltage: 2.2 V min, 5.5 V absolute max

Input low voltage: 1.5 V max, -0.5 V absolute min, 0 V recommended min

Output high voltage: 4.4 V min (IOH = -50 μA), 3.76 V min (IOH = -24 mA)

Output low voltage: 0.1 V max (IOL = 50 μA), 0.44 V max (IOL = 24 mA)

Output current: ± 24 mA max per terminal

Counters

Counter terminal names: CTR0, CTR1

Counter type: Event counter

Number of channels: 2

Input type: Schmitt trigger, 33 Ω series resistor, 47 k Ω pull-down to ground

Schmitt trigger hysteresis: 0.4 V to 1.2 V

Input high voltage: 2.2 V min, 5.5 V absolute max

Input low voltage: 1.5 V max, -0.5 V absolute min, 0 V recommended min

Resolution: 32 bits

Max input frequency: 20 MHz

Counter read/write rates (software paced): 33 to 8000 reads/writes per second typ, system-dependent

High pulse width: 25 ns min

Low pulse width: 25 ns min

Timer

Timer terminal name: TMR

Timer type: PWM output with count, period, delay, and pulse width registers

Output value: Default state idle low, pulses high, software-selectable output invert

Internal clock frequency: 40 MHz

Register widths: 32 bits

High pulse width: 20 ns min

Low pulse width: 20 ns min

Output high voltage: 4.4 V min (IOH = -50 μA), 3.76 V min (IOH = -24 mA)

Output low voltage: 0.1 V max (IOL = 50 μA), 0.44 V max (IOL = 24 mA)

Output current: ± 24 mA max per pin

Power

Operating modes: Bus-powered, USB 5 V supply

Supply current

Suspend mode: < 2.5 mA

Enumeration: < 100 mA

Run mode: < 500 mA

Power consumption, excluding analog and digital outputs

Run mode

USB-1208HS: 1.05 W max (210 mA input current)

USB-1208HS-2AO: 1.125 W max (225 mA input current)

USB-1208HS-4AO: 1.175 W max (235 mA input current)

Power available for 5 V, AICKO, AOCKO, TMR, analog outputs, digital I/O

Run mode

USB-1208HS: 1.45 W max

USB-1208HS-2AO: 1.375 W max

USB-1208HS-4AO: 1.325 W max

The total power consumption for all external loads must be $<$ this value; each load must meet the individual specification for the terminal.

Digital output power calculation: Power per output = Iout * 5 V (example: @ 24 mA, P = 0.024 * 5 = 120 mW/output)

Analog output power calculation: Power per output = (Iout * 16.5 V) / 0.78 (example: @ 3 mA, P = (0.003 * 16.5) / 0.78 = 63.5 mW/output)

5 V output power calculation: Power (W) = Iout * 5 V

5 V output voltage range (assumes input power is within specified limits)

Run mode: 4.25 V min, 5.25 V max

Suspend mode, enumeration: 0 V

5 V output current

Run mode, no other output loads: 265 mA max (1.325 W)

Fuses (on USB supply): 0452.750 - Littelfuse 0.750A NANO2@ Slo-Blo® Subminiature Surface Mount Fuse. Spare fuse mounted in holder on PCB.

USB-1208HS Series

Ordering



Order Information

Hardware

Part No.	Description
USB-1208HS	High-speed 13-bit DAQ device with eight SE or four DIFF analog inputs, two 32-bit external event counters, a 32-bit PWM timer output, and 16 digital I/O lines.
USB-1208HS-2AO	High-speed 13-bit DAQ device with eight SE or four DIFF analog inputs, two 12-bit analog outputs, two 32-bit external event counters, a 32-bit PWM timer output, and 16 digital I/O lines.
USB-1208HS-4AO	High-speed 13-bit DAQ device with eight SE or four DIFF analog inputs, four 12-bit analog outputs, two 32-bit external event counters, a 32-bit PWM timer output, and 16 digital I/O lines.

Software also Available from MCC

Part No.	Description
DAQami	Data acquisition companion software for acquiring data and generating signals
TracerDAQ Pro	Out-of-the-box virtual instrument suite with strip chart, oscilloscope, function generator, and rate generator – professional version
DASyLab	Icon-based data acquisition, graphics, control, and analysis software