

USB-2020

12-bit, 20 MS/s, Simultaneous-Sampling, Ultra High-Speed USB Board

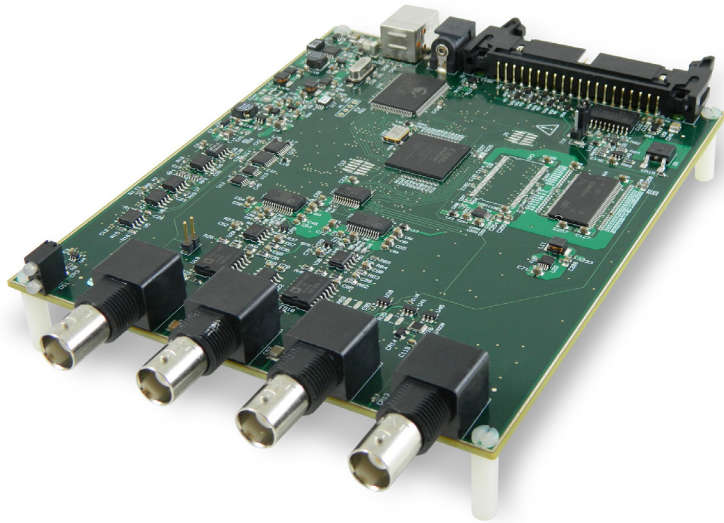

The USB-2020 offers high-speed simultaneous sampling at rates up to 20 MS/s per channel to onboard memory.

Overview

The USB-2020 is a high-speed two-channel data acquisition board that provides simultaneous sampling at rates up to 20 MS/s per channel. Users can sample data from both channels at an overall rate of 40 MS/s to the 64 megasample onboard memory, or continuously stream data to a host computer at up to 8 MS/s for one or both channels over a high-speed USB connection.

Each channel has its own A/D converter for simultaneous sampling to eliminate channel skew and ensure phase information between channels is maintained.

Flexible triggering and gating ensures data is acquired when needed. The clock I/O input allows acquisitions to be controlled by the onboard clock or by an external clock source for applications that require user-supplied pacing.

The board provides signal connections through four standard BNC connectors and a 40-pin auxiliary connector.

AI Acquisition Modes

The USB-2020 can acquire analog data using BURSTIO or continuous scan mode.

BURSTIO

BURSTIO enables a device to acquire data at higher rates than are supported by the USB data transfer rate.

In BURSTIO, the USB-2020 can sample data to onboard memory at rates up to 20 MS/s per channel.

Because each channel has its own A/D converter, an overall sample rate of 40 MS/s is achieved when sampling both channels. The simultaneous sampling eliminates channel skew and maintains phase coherence between the two channels.

The memory buffer can store up to 64 megasamples at the maximum rate for transfer to the computer after the acquisition is complete.

Continuous Scan Mode

Continuous scan mode enables data to be directly transferred to the host computer during acquisition. The maximum rate in continuous scan mode is 8 MS/s for all acquired data (one channel or two channels). The maximum rate achieved depends on the host computer.

Features

- Two 20 MS/s simultaneous-sampling analog inputs
- 12-bit resolution
- 64 megasample onboard memory
 - 40 MS/s overall rate to onboard memory when acquiring from both channels
 - 8 MS/s throughput to host PC
- Analog and digital triggering and gating
- Internal or external pacing of analog scans
- Eight digital I/O lines
- BNC connectors and 40-pin auxiliary connector for signal connections

Supported Operating Systems

Windows® 10/8/7/Vista®XP
32/64-bit

External Clock I/O

USB-2020 analog input scanning operations can be paced with the internal A/D clock or with an external clock source. The CLK IO connector can be configured through software for input (default) for external pacing, or for output to pace a connected device.

Trigger Input

The USB-2020 supports software-selectable digital and analog triggers and gates.

- Digital triggers can be configured for rising or falling edge, or for high or low level.
- Analog triggers can be configured for above or below level, or for rising or falling edge with hysteresis.
- Digital gates can be configured for high or low level.
- Analog gates can be configured for software-selectable high or low level, or for in or out of window.

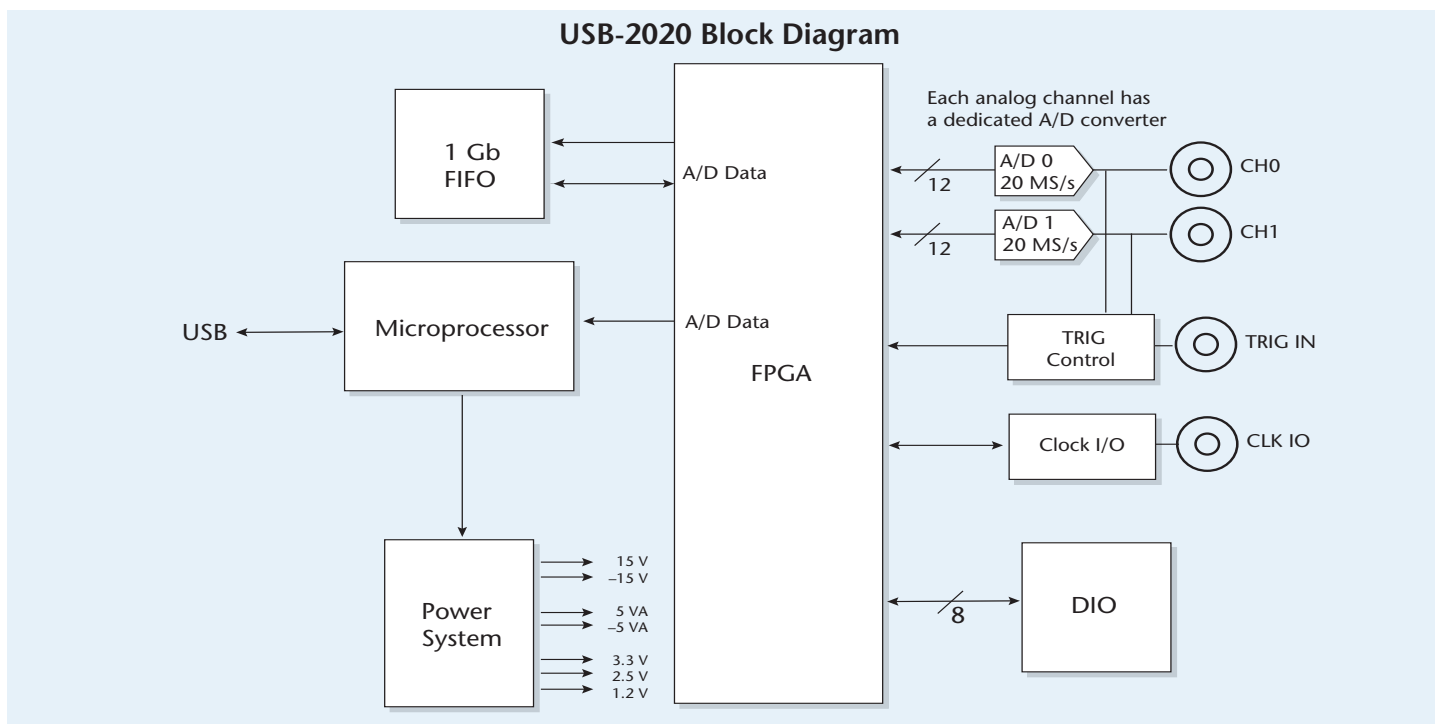

An analog scan can have a trigger *or* a gate, but not both. For example, an analog trigger cannot be used at the same time as the TRIG IN BNC connector is being used to gate.

Digital I/O

The USB-2020 provides eight digital I/O lines on the 40-pin auxiliary connector. When a bit is configured for input, it can detect the state of any TTL-level input. Each DIO channel is an open-drain, and can sink up to 150 mA for direct drive applications when used as an output.

External Pull-Up Capability

Digital inputs are pulled high by default to 5 V through 47 k Ω resistors. The pull-up voltage is common to all 47 k Ω resistors.

The pull-up/pull-down state can be changed from a header on the board. An external pull-up resistor can also be used to pull the DIO bit up to a voltage that exceeds the internal 5 V pull-up voltage (15 V maximum).

Calibration

The USB-2020 is factory-calibrated using a NIST-traceable calibration process. Specifications are guaranteed for one year.

The USB-2020 also supports field calibration for users to calibrate the device locally with the InstaCal utility.

BNC and 40-Pin Auxiliary Connectors

The USB-2020 provides four standard BNC connectors for both analog inputs, trigger input, and clock I/O. Use standard BNC cables to connect the BNC female connectors.

The board also includes a 40-pin auxiliary connector for the eight digital I/O, two 5 V power outputs, and an alternate trigger input connection. The signals available from the 40-pin auxiliary connector require a separately-purchased cable.







Field Wiring and Signal Termination

Use the following cables and accessories to connect to the signals available from the 40-pin auxiliary connector:

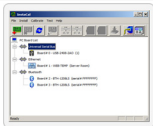
- **C40FF-x**: 40-pin ribbon cable, female to female; connects the 40-pin auxiliary connector to a CIO-MINI40 universal screw-terminal board.
- **C40-37F-x**: 40-pin female IDC to 37-pin female D shell; connects the 40-pin auxiliary connector to a CIO-MINI37 universal screw-terminal board or SCB-37 signal connector box.

Software Support

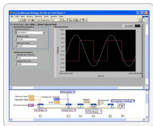
The USB-2020 is supported by the software in the table below.

Ready-to-Run Applications	
DAQami™ 	Data acquisition companion software with drag-and-drop interface that is used to acquire, view, and log data, and generate signals. DAQami can be configured to log analog, digital, and counter channels, and to view that data in real-time or post-acquisition on user-configurable displays. Logged data can be exported for use in Excel® or MATLAB®. Windows OS DAQami is included with the free MCC DAQ Software bundle (CD/download). Install DAQami and try the fully-functional software for 30 days. After 30 days, all features except for data logging and data export will continue to be available – data logging and data export features can be unlocked by purchasing the software.
InstaCal™ 	An interactive installation, configuration, and test utility for MCC hardware. Windows OS InstaCal is included with the free MCC DAQ Software bundle (CD/download).
TracerDAQ™ and TracerDAQ Pro 	Virtual strip chart, oscilloscope, function generator, and rate generator applications used to generate, acquire, analyze, display, and export data. Supported features may vary by hardware. The Pro version provides enhanced features. Windows OS TracerDAQ is included with the free MCC DAQ Software bundle (CD/download). TracerDAQ Pro is available as a purchased software download.
General-Purpose Programming Support	
Universal Library™ (UL) 	Library for developing applications in C, C++, VB, C# .Net, VB .Net, and Python. Windows OS The UL is included with the free MCC DAQ Software bundle (CD/download).
Linux® driver 	Open-source Linux drivers are available for most MCC devices. Example programs are also provided.
Application-Specific Programming Support	
ULx for NI LabVIEW™ 	A comprehensive library of VIs and example programs for NI LabVIEW that is used to develop custom applications that interact with most MCC devices. Windows OS ULx for NI LabVIEW is included with the free MCC DAQ Software bundle (CD/download).
DASYLab® 	Icon-based data acquisition, graphics, control, and analysis software that allows users to create complex applications in minimal time without text-based programming. Windows OS DASYLab is available as a purchased software download. An evaluation version is available for 28 days.
MATLAB® driver 	High-level language and interactive environment for numerical computation, visualization, and programming. The Mathworks Data Acquisition Toolbox™ allows users to acquire data from most MCC PCI and USB devices. Visit www.MathWorks.com for more information about the Data Acquisition Toolbox.

Specifications

All specifications are subject to change without notice.
Typical at 25 °C unless otherwise specified.

Analog Input

A/D converter type: AD9225

Number of channels: 2

Resolution: 12-bits

Input configuration: Single-ended, individual A/D per channel

Sampling method: Simultaneous

Input ranges: ± 10 V, ± 5 V, ± 2 V, ± 1 V, software-selectable

Connection type: BNC

Input coupling: DC

Absolute maximum input voltage: ± 15 V max (power on)

Input impedance: 1.5 M Ω typ

Input leakage current: 2 μ A typ, 10 μ A max

Input bandwidth (3 db): All input ranges, 17 MHz typ

Crosstalk: DC to 10 kHz, -90 dB

Trigger source

Digital: TRIG IN (BNC connector or 40-pin connector)

See [External trigger](#) for more information

Analog: CH0 or CH1

Sample clock source

Internal: 1 kHz to 20 MHz max

External: CLK IO (BNC connector)

See [External clock input/output](#) for more information

Throughput

Continuous scan: 1 kS/s min to 8 MS/s max to host computer (maximum rate is system-dependent)

BURSTIO: 1 kS/s min to 20 MS/s max to 64 MS onboard memory

Signal-to-noise ratio (SNR): 66.6 dB

Signal-to-noise and distortion ratio (SINAD): 66.5 dB

Spurious free dynamic range (SFDR): 80 dB

Total harmonic distortion (THD): 80 dB

Noise Performance

For the peak-to-peak noise distribution test, a single-ended input channel is connected to AGND at the input BNC connector and 20,000 data samples are acquired at the maximum rate.

Range	Counts	LSBrms
± 10 V	5	0.76
± 5 V	5	0.76
± 2 V	7	1.06
± 1 V	7	1.06

Analog Input Calibration

Recommended warm-up time: 15 minutes min

Calibration method: Self calibration, with calibration factors for each range stored onboard in non-volatile memory

Calibration interval: 1 year (factory calibration)

DC Accuracy Components and Specifications. All Values are (\pm)

Range	Gain Error (% of reading)	Offset Error (mV)	INL Error (% of range)	Absolute Accuracy at Full Scale (mV)	Gain Temperature Coefficient (% reading/ $^{\circ}$ C)	Offset Temperature Coefficient (μ V/ $^{\circ}$ C)
± 10 V	0.11	5.2	0.0976	35.72	0.0035	30
± 5 V	0.11	5.2	0.0488	20.46	0.0035	110
± 2 V	0.11	1.1	0.0244	8.18	0.0035	10
± 1 V	0.11	1.1	0.0122	4.64	0.0035	25

Digital Input/Output

Digital type: CMOS

Number of I/O: 8

Configuration: Each bit can be independently configured as input (power on default) or output. Input bits can be read at any time whether the digital output is active or tri-stated.

Input voltage range: 0 V to 15 V

Input characteristics: 47 k Ω pull-up/pull-down resistor, 28 k Ω series resistor

Abs. maximum input voltage: +20 V max

Pull-up/pull-down configuration: The port has 47 k Ω resistors that can be configured as pull-up or pull-down with an internal jumper. The factory configuration is pull-up (J10 shorting block default position is pins 1 and 2)

Pull down capability is available by placing the J10 shorting block across pins 2 and 3.

Digital I/O transfer rate (software paced): 33 S/s to 4,000 S/s typ; system-dependent

Input high voltage: 2.0 V min

Input low voltage: 0.8 V max

Output characteristics: 47 k Ω pull-up, open drain (DMOS transistor, source connected to ground)

Output voltage range: 0 V to 5 V (using 47 k Ω internal pull up resistors); 0 V to 15 V max through optional, user-supplied external pull-up resistors

Adding external pull-up resistors connects the output bit in parallel with the internal 47 k Ω pull-up resistor. The resulting load voltage depends on the value of the external resistor value and the pull-up voltage used. In general, external 10 k Ω pull-up resistors are sufficient for most applications.

Drain to source breakdown voltage: 42.5 V min (does not include the additional leakage current contribution that can occur when using an external pull-up resistor)

Off state leakage current: 1.0 μ A

Sink current capability: 150 mA max (continuous) per output pin; 150 mA max (continuous), total for all eight channels

DMOS transistor on-resistance (drain to source): 4 Ω

External Trigger

Trigger Source

Digital: TRIG IN on BNC connector and 40-pin connector)

Analog: CH0 or CH1

Trigger mode

Digital: Rising or falling edge, high or low level

Analog: Trigger above or below software-selectable level, rising or falling edge with software-selectable hysteresis

A/D gate source

Digital: TRIG IN (BNC connector and 40-pin connector)

Analog: CH0 or CH1

A/D gate modes

Digital: High or low level

Analog: Software-selectable high or low level, in or out of software-selectable window

Trigger latency: 50 ns max

Trigger pulse width: 25 ns min

Input type: 49.9 Ω series resistor

Input high voltage: 2.0 V min

Input low voltage: 0.8 V max

External Clock Input/Output

Terminal name: CLK IO (BNC connector)

Terminal type: ADC clock input/output, software-selectable for input or output (default is input)

Terminal description: When configured for input, receives sampling clock from external source

When configured for output, outputs the internal sampling clock

Clock rate: 1 kHz to 20 MHz max

Stability: ± 50 ppm

Input impedance: 1 M Ω

Input threshold

High: 2.0 V min

Low: 0.8 V max

Maximum rate: 20 MHz

Input range: 0 V to 5.5 V

Clock pulse width: 25 ns min

Input type: 49.9 Ω series resistor

Input high voltage: 2.0 V min

Input low voltage: 0.8 V max

Output high voltage: 2.4 V min

Output low voltage: 0.4 V max

Output current: 24 mA max

Memory

Data FIFO: 64 MS using BURSTIO, 4 kS not using BURSTIO

Non-volatile memory: 32 KB (30 KB firmware storage, 2 KB calibration/user data)

Power

Supply voltage: 9 VDC to 18 VDC (MCC plug-in power supply CB-PWR-9 recommended)

Supply current: 0.75 A max (this is the total quiescent current requirement for the device that includes up to 10 mA for the Status LED. This value does not include potential loading of the DIO bits or the +VO pin)

Power jack configuration: Two conductor, barrel

Power jack barrel diameter: 6.3 mm

Power jack pin diameter: 2.0 mm

Power jack polarity: Center positive

+VO voltage range: 4.50 V to 5.25 V

+VO current sourcing: 10 mA max.

Environmental

Operating temperature range: 0 °C to 50 °C max

Storage temperature range: -40 °C to 85 °C max

Humidity: 0% to 90% non-condensing max

Mechanical

Dimensions (L x W x H): 142.24 x 180.34 x 38.09 mm (5.6 x 7.1 x 1.5 in.)

Weight: 1.5 lb

USB

USB device type: USB 2.0 (high-speed)

Device compatibility: USB 2.0

USB cable type: A-B cable, UL type AWM 2527 or equivalent

(min 24 AWG VBUS/GND, min 28 AWG D+/D-)

USB cable length: 3 m (9.84 ft) max

Signal I/O Connectors

USB: B type

Auxiliary connector (J9): 40-pin header connector

Compatible cables for the 40-pin auxiliary connector: C40FF-x and C40-37F-x

Compatible accessory products with the C40FF-x cable: CIO-MINI40

Compatible accessory products with the C40-37F-x cable: CIO-MINI37 and SCB-37

BNC Connectors

CH0: Analog input channel 0

CH1: Analog input channel 1

TRIGIN: BNC connection for external digital trigger (also available on the auxiliary connector J9)

CLK IO: BNC connection for the ADC clock I/O, software-selectable for input or output

Order Information

Hardware

Part No.	Description
USB-2020	Ultra high-speed, simultaneous sampling USB DAQ board with 2 SE analog inputs, 20 MS/s throughput to internal memory, analog/digital triggers and gates, clock I/O, and 8 digital I/O lines. Includes power supply (MCC p/n CB-PWR-9), USB cable, and standoffs.

Accessories & Cables

Part No.	Description
C40FF-x	40-conductor ribbon cable, female to female ($x = 1, 2, 3, 4, 5, 10, 15, 20, 25,$ and 50 foot lengths)
CIO-MINI40	Universal 40-pin screw-terminal board, connects via a C40FF-x cable
C40-37F-x	40-pin ribbon cable, female IDC to 37-pin female D shell ($x = 1, 2, 3, 4, 5, 10, 15, 20, 25,$ and 50 foot lengths)
CIO-MINI37	Universal 37-pin screw-terminal board, connects via a C40-37F-x cable
SCB-37	Shielded 37-pin signal connection box, connects via a C40-37F-x cable

Software also Available from MCC

Part No.	Description
DAQami	Easy-to-use advanced data logging software to acquire, view, and log data
TracerDAQ Pro	Out-of-the-box virtual instrument suite with strip chart, oscilloscope, function generator, and rate generator – professional version
DASYLab	Icon-based data acquisition, graphics, control, and analysis software